

HDL3

DIRECTIONAL SOLENOID VALVE

280 bar 50 l/min

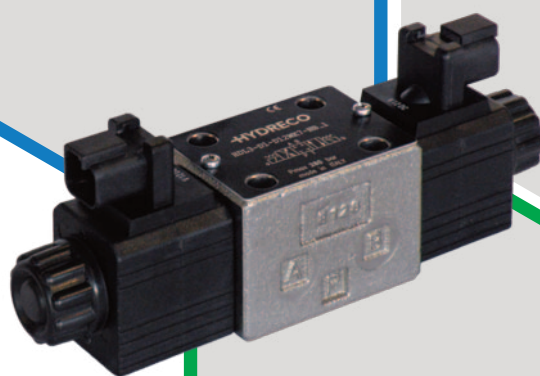

INTRODUCTION

The HDL3 valves are solenoid directional valves, direct operated, with porting pattern compliant to ISO 4401-03 standards.

These valves are supplied with a zinc-nickel plating making them the perfect choice for mobile and environmental applications that require better protection.

Salt spray resistance up to 600 h (test according to UNI EN ISO 9227 and UNI EN ISO 10289 tests and standards).

The valve body is made with high strength iron castings with internal passages designed to minimize pressure drop.

FLUIDS

Use mineral oil-based hydraulic fluids HL or HM type, according to ISO 6743-4. For these fluids, use NBR seals. For fluids HFDR type (phosphate esters) use FPM seals (code V). For the use of other kinds of fluid such as HFA, HFB, HFC, please consult our technical department.

Using fluids at temperatures higher than 80 °C (180 °F) causes the accelerated degradation of seals as well as the fluid physical and chemical properties.

From a safety standpoint, temperatures above 55 °C (130 °F) are not recommended.

OPERATING PARAMETERS

MAXIMUM OPERATING PRESSURE	P - A - B ports	280 bar	4000 psi
	T port	250 bar	3600 psi
FLOW RATE		50 l/min	13.2 gpm
MOUNTING SURFACE		ISO 4401-03-02-0-05 NFPA D03	
STEP RESPONSE	0 → 100%	25 ÷ 75 ms	
	100 → 0%	15 ÷ 25 ms	
WEIGHT	single solenoid	1.1 kg	2.4 lbs
	double solenoid	1.4 kg	3.1 lbs
RANGE TEMPERATURES	ambient	-20 to +54 °C	-4 to +130 °F
	fluid	-20 to +82 °C	-4 to +180 °F
FLUID VISCOSITY	range	10 - 400 cSt	60 - 1900 SUS
	recommended	25 cSt	120 SUS
FLUID CONTAMINATION		ISO 4406:1999 class 20/18/15	

HYDRAULIC SYMBOLS (TYPICAL)

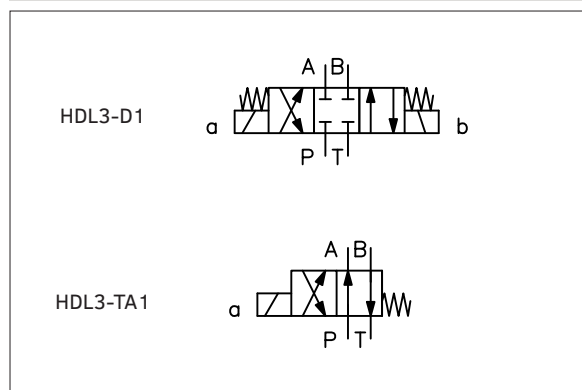

HDL3 - ■ ■ - ■ ■ - ■ ■ - 1

design mark

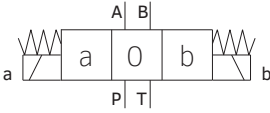
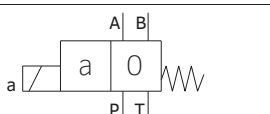
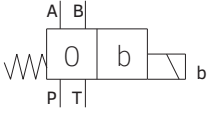
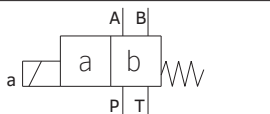
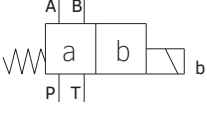
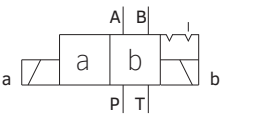
FUNCTION	
D	 <p>double solenoid 3 positions - spring centred</p>
A	 <p>single solenoid at side A 2 positions - spring return</p>
B	 <p>single solenoid at side B 2 positions - spring return</p>
TA	 <p>single solenoid at side A 2 positions - spring return</p>
TB	 <p>single solenoid at side B 2 positions - spring return</p>
K	 <p>double solenoid and detent 2 positions</p>

VOLTAGE	
D12	12 V DC solenoid
D24	24 V DC solenoid
D28	28 V DC solenoid
D48	48 V DC solenoid
D00	without coils

COIL	
K1	DIN 43650
K2	AMP Junior
K4	lead wires
K7	DT04-2P 'deutsch' zinc-nickel plated
K8	Amp Superseal

MANUAL OVERRIDE	
B	built-in with the tube, boot protected (standard)
K	knob, turning

SEAL	
N	NBR (standard)
V	Viton

SPOOL
See next page

CODE EXAMPLE:
HDL3 - D1 - D12WK7 - NB - 1

Flow characteristic curves obtained with mineral oil with viscosity of 36 cSt (170 sus) at 50 °C (122 °F) and 24V DC valve; the Δp values are measured between P and T (full loop) valve ports.

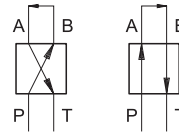

The operating limits can be considerably reduced if a 4-way valve is used as 3-way valve with port A or B plugged or without flow.

PRESSURE DROPS Δp -Q

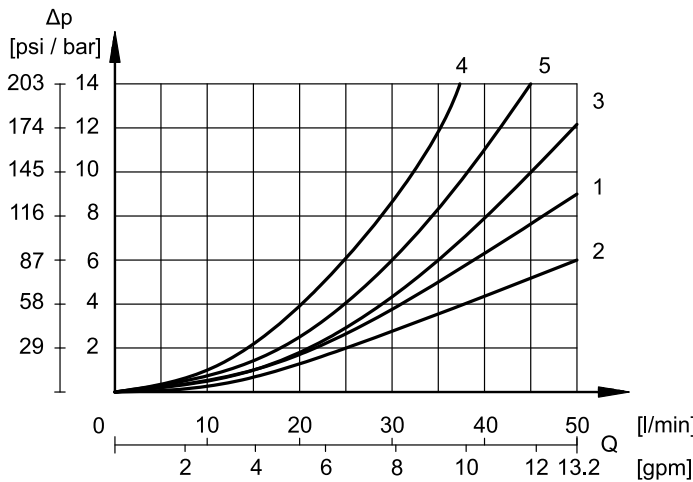

ENERGIZED POSITION

TYPE	FLOW DIRECTION			
	P→A	P→B	A→T	B→T
	CURVES ON GRAPH			
D1, A1, B1	1	1	1	1
D2, A2, B2	1	1	2	2
D3, A3, B3	3	3	2	2
D4, A4, B4	4	4	4	4
TA1, TB1	1	1	1	1
K1	3	3	3	3

DE-ENERGIZED POSITION

TYPE	FLOW DIRECTION				
	P→A	P→B	A→T	B→T	P→T
	CURVES ON GRAPH				
D2, A2, B2					3
D4, A4, B4					5

PERFORMANCE CURVES - STANDARD OPERATION

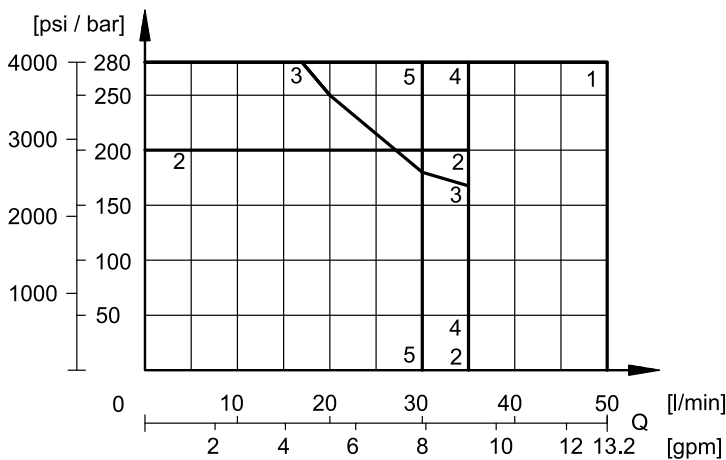

TYPE	CURVE
D1, TA1	1
D2	2
D3	3
D4	4
K	5

Solenoids are made up of two parts: tube and coil.

The tube is threaded into the valve body and includes the armature that moves immersed in oil, without wear. The inner part, in contact with the oil in the return line, ensures heat dissipation.

The coil is fastened to the tube by a retainer, and can be indexed 360°, to suit the clearance space.

It is possible to feed D48 coils with alternating current (50 or 60 Hz) using connectors with built-in Graetz bridge rectifier. In this case consider a reduction of the operating limits.

Contact us to order coils as spare parts.

DUTY CYCLE	100%	
MAXIMUM SWITCH ON FREQUENCY	10,000 cycles/hr	
SUPPLY VOLTAGE FLUCTUATION	± 10% Vnom	
ELECTROMAGNETIC COMPATIBILITY (EMC)	2014/30/EU	
LOW VOLTAGE	2014/35/EU	
PROTECTION CLASS FOR INSULATION	copper wire	class H (180 °C)
	coil	class H (180 °C)

(values ± 10%)

	Nominal voltage [V]	Resistance at 20°C [Ω]	Current consumpt. [A]	Power consumpt [W]
D12	12	5.4	2.2	26.5
D24	24	20.7	1.16	27.8
D28	28	27.5	1.02	28.5
D48	48	82	0.58	28

Declared IP degrees are intended according to EMC 2014/30/EU, only for both valve and connectors of an equivalent IP degree, installed properly.

K7 and K8 coils reach a better IP degree than standard coils thanks to some constructive measures. Because of the plastic coil and the zinc-nickel coating on the valve body, these valves have a salt spray resistance up to 600 hours (test performed according to UNI EN ISO 9227 and assessment test performed according to UNI EN ISO 10289).

Mating connectors are not included in solenoid valves delivery. Connectors for K1 coils can be ordered separately.

K1

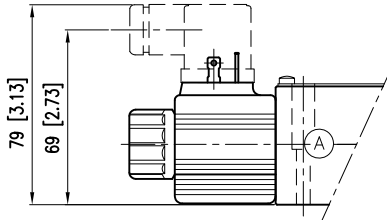

DIN 43650 (EN 175301-803)

Mating connectors type ISO 4400 / DIN 43650 (EN 175301-803).

IP degree of electrical connection: IP66

IP degree of whole valve: IP66

K2

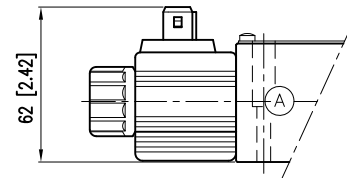

AMP Junior

IP degree of electrical connection: IP65/IP67

IP degree of whole valve: IP65/IP67

K4

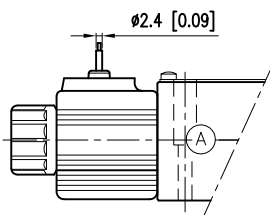

OUTGOING WIRES

Two outgoing wires of 1 metre length.

IP degree of electrical connection: IP65

IP degree of whole valve: IP65

K7

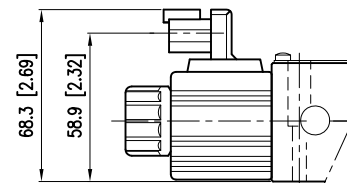

DEUTSCH DT04 MALE

IP degree of electrical connection: IP65/IP68/IP69

IP degree of whole valve: IP65/IP68/IP69

IP degree according to ISO 20653: IP69K

K8

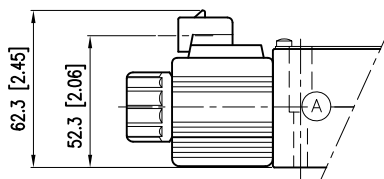

AMP SUPERSEAL

IP degree of electrical connection: IP66/IP68/IP69

IP degree of whole valve: IP66/IP68/IP69

IP degree according to ISO 20653: IP69K

HDL3 DOUBLE SOLENOID (K7 COIL)

dimensions in mm [in]

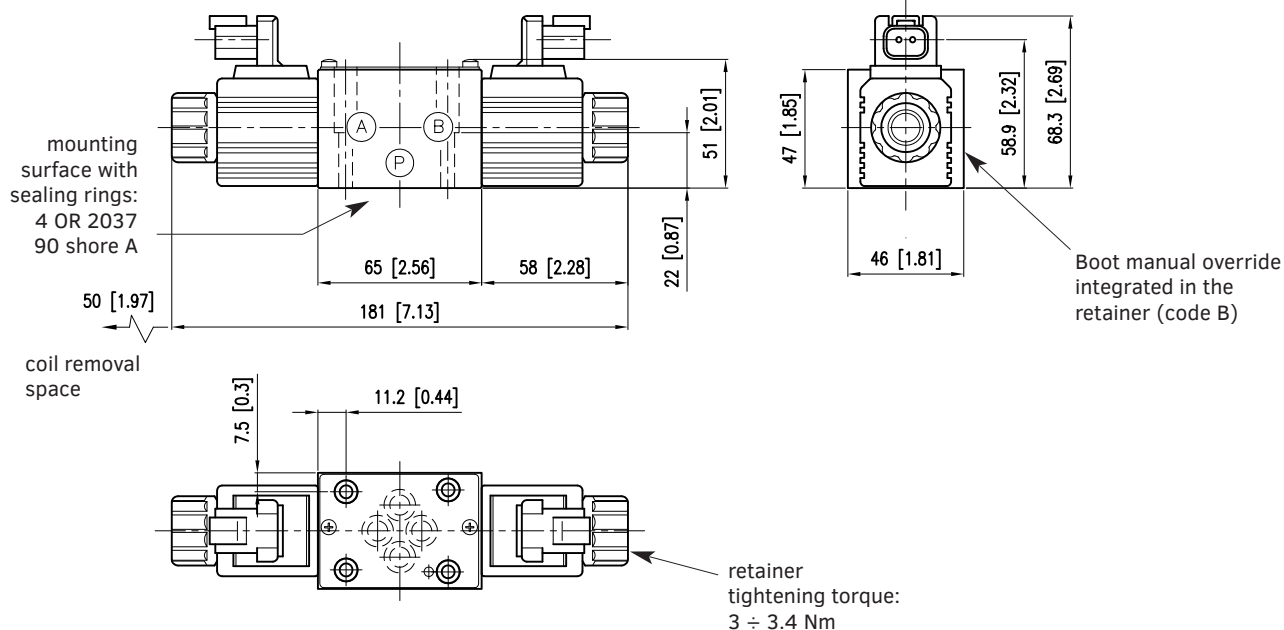

HDL3 SINGLE SOLENOID SIDE A (K7 COIL)

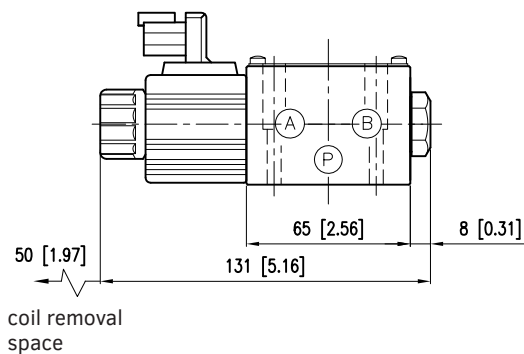

HDL3 SINGLE SOLENOID SIDE B (K7 COIL)

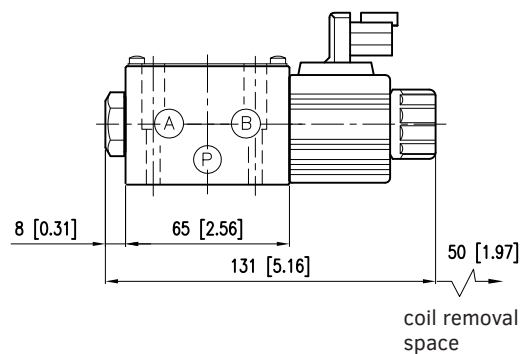

Fastening bolts:

4 SHCS M5x30 - ISO 4762 - torque 5 Nm (A 8.8)

Threads of mounting holes: M5x10

The standard valve has override pins integrated in the tube and protected by the boot-retainer.

Turning knob override is also available, entering the proper code in the model number.

Actuate this override by pushing it with a suitable tool, or by hand, minding not to damage the rubber surface.

BOOT-PROTECTED

Code B

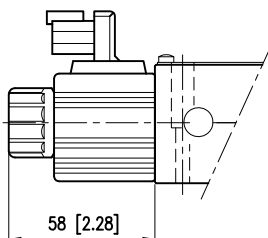

KNOB, TURNING

Code K

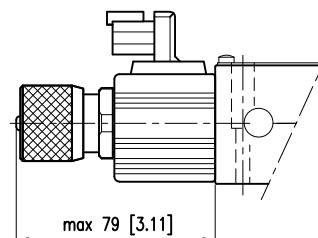

IP DEGREE TIPS

The technical reference standard for IP degree is IEC 60529, which classifies and rates the degree of protection provided by equipments and electrical enclosures against intrusions.

The first digit (6) concerns the protection from solid particles (body parts to dust).

The second digit of the IP rating concerns the liquid ingress protection. It indicates three different types of atmospheric agents from which protection is provided:

Values from 1 to 6 → water jets.

Values 7 and 8 → immersion.

Value 9 → high pressure and high temperature water jets.

This means that IP66 covers all the lower steps, rating IP68 covers IP67 but not IP66 and lower. Instead, IP69 does not cover any of them. Whether a device meets two types of protection requirements it must be indicated by listing both separated by a slash. (E.g. a marking of an equipment covered both by temporary immersion and water jets is IP66/IP68).

INSTALLATION

These valves can be installed in any position without impairing correct operation.

Ensure that there is no air in the hydraulic circuit.

Valves are fixed by means of screws or tie rods on a flat surface with planarity and roughness equal to or better than those indicated in the relative symbols. If minimum values are not observed, fluid can easily leak between the valve and support surface.

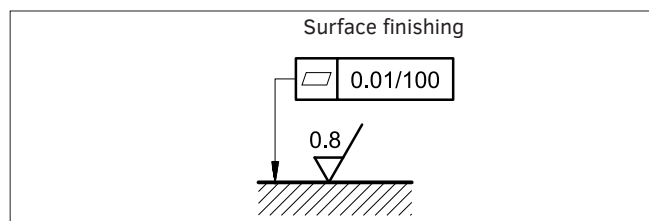

Supported by a worldwide network



CONTACT INFORMATION

EMEA

GERMANY	Hydreco Hydraulics GmbH, Straelen (NRW)	☎ +49 283494303-41	✉ info-de@hydreco.com
ITALY	Hydreco Hydraulics Italia Srl, Vignola (MO)	☎ +39 059 7700411	✉ sales-it@hydreco.com
ITALY	Hydreco Hydraulics Italia Srl, Parma (PR)	☎ +39 0521 1830520	✉ sales-it@hydreco.com
ITALY	Hydreco Srl, San Cesario S/P (MO)	☎ +39 059 330091	✉ cylinders@hydreco.com
NORWAY	Hydreco Hydraulics Norway AS, Nittedal	☎ +47 22909410	✉ post-no@hydreco.com
UK	Hydreco Hydraulics Ltd, Poole, Dorset	☎ +44 (0) 1202 627500	✉ info-uk@hydreco.com

AMERICAS

NORTH/LATIN	Hydreco Inc / Continental Hydraulics Inc, Shakopee (MN)	☎ +1 952 895 6400	✉ sales@conthyd.com
--------------------	---	-------------------	---------------------

APAC

AUSTRALIA	Hydreco Hydraulics Pty Ltd, Seven Hills (NSW)	☎ +61 2 9838 6800	✉ sales-au@hydreco.com
AUSTRALIA	Hydreco Hydraulics Pty Ltd, Welshpool (WA)	☎ +61 8 9377 2211	✉ reception-wa@hydreco.com
INDIA	Hydreco Hydraulics India Private Ltd, Bangalore	☎ +91 80 67656300	✉ sales-in@hydreco.com